

# Fish-habitat associations in the region offshore from James Price Point – a rapid assessment using Baited Remote Underwater Video Stations (BRUVS)

Mike Cappo<sup>1</sup>, Marcus Stowar<sup>1</sup>, Craig Syms<sup>1</sup>, Charlotte Johansson<sup>2</sup> & Tim Cooper<sup>1</sup>

<sup>1</sup> Australian Institute of Marine Science, PMB 3, Townsville MC, Qld 4815.

✉ mcappo@aims.gov.au

<sup>2</sup> School of Marine and Tropical Biology, James Cook University, Qld 4811.

*Manuscript received December 2010; accepted April 2011*

## Abstract

A “snapshot” of the fish-habitat associations in the vicinity of James Price Point was obtained during a single expedition in October 2009, when Baited Remote Underwater Video Stations (BRUVS) were deployed in coastal waters to survey the demersal and semi-demersal ichthyofauna. A total of 7108 individuals from 116 species of fishes, sharks, rays and sea snakes were recorded from 154 sites. Bony fishes were represented by 8 orders, and cartilaginous fishes were well represented by the Carcharhiniformes, Rajiformes and Orectolobiformes. There were 2 species of hydrophiid sea snakes. Multivariate analysis showed that species responded to the amount of epibenthic cover in the study area and that there was an interaction between depth and sediment composition, as well as depth and epibenthic cover, in defining four fish assemblages to the north and south of James Price Point. Diversity appeared to increase with depth amongst these assemblages. The sandy seabed offshore from James Price Point was inhabited by a “deep sandy” fish assemblage, which intruded inshore across the study area, and was characterised by the presence of ponyfish (*Leiognathus*), threadfin bream (*Nemipterus*) and queenfish (*Scomberoides*). On either side were shallow, northern and deeper, southern, assemblages inhabiting “gardens” of macroalgae, filter-feeders and some seagrass beds. These epibenthic habitats at the northern and southern ends of the survey area were clearly important to many species, but in general there appeared to be little association of particular vertebrate species or biotic habitat types with the James Price Point area itself. The study area was notable for the diversity and abundance of the fauna, given the shallow depth, lack of rugose seafloor topography and lack of sub-tidal coral reefs in the area sampled. Coarse comparison with the fauna at similar distance to shore in similar latitudes in the Great Barrier Reef Marine Park, the Burrup Peninsula and the Kimberley indicated that the study area had more small pelagic planktivores and more large semi-demersal predators. There was also an absence of some species normally associated with muddy seafloors and fringing coral reefs that are common on BRUVS set elsewhere in regions with less extreme tidal ranges.

**Keywords:** fish-habitat, James Price Point, Kimberley, BRUVS

## Introduction

The inshore margins of tropical shelves are comprised of mosaics of soft-bottom communities interspersed with shoals, patches and isolates of ‘hard ground’ supporting large epibenthic plants and filter-feeders. Knowledge of fish-habitat associations in these mosaics is generally very poor in the Kimberley coast, with few inshore surveys (Hutchins 2001, Travers *et al.* 2006, 2010). This paucity contrasts starkly with paradigms about the importance to fishes of sponges, and other megabenthos, derived from trawl grounds of the north-west shelf (Sainsbury *et al.* 1997). In comparison to shallow reefal habitats studied elsewhere, the Kimberley coast poses special challenges due to its remote location, extreme tidal movements, episodic storms, and heavy load of suspended materials in the water column. The abundance of crocodiles, sharks and toxic stinging jellyfish also discourage direct observation by SCUBA divers. Despite these conditions, underwater visual

surveys (UVC) using timed “zig-zag” swims have been used to describe the ichthyofauna at coastal sites between Broome and Cape Leveque at depths mainly shallower than 20 metres by Hutchins (2001). Demersal trawl gear and baited fish traps have also been used in deeper waters in the Canning bioregion to describe ichthyofaunal groupings on “soft” and “hard” seabeds (Travers *et al.* 2006, 2010). These studies have been aimed mainly at detecting spatial boundaries and placing the ichthyofauna in a bioregional context (*e.g.* Fox & Beckley 2005), and have not incorporated fine-scale measurements of the nature of sediments and epibenthos at the sampling sites.

Environmental impact studies for the proposed industrial development of the James Price Point region require biologically-informed spatial models of species occurrence at much smaller scales of association of fish species with features of the local seabed. The challenge in providing useful information on the local ichthyofauna is therefore two-fold. Firstly, standardised approaches to sample all depths and seafloor topographies of the region must be applied. Such techniques should simultaneously



measure fish and habitat covariates and have the least selectivity possible, given the fact that a narrow focus in baseline studies and monitoring programs (on a few economically important predators for example) has high risk of failing to detect fundamental changes in biodiversity. Secondly, robust models must be developed that explain and predict the distribution of species and assemblages along critical environmental gradients.

In this rapid assessment we used a harmless baited video technique that offered the benefits of detecting fishes of any size for visual census on seabed topographies of any rugosity and depth. This techniques records mobile fish passively traversing the field of view or actively following the bait plume, and allows direct observation of the fine-scale substratum and epibenthos inhabited by the fish in the field of view. Baited videophotography has proven especially successful in studies of abyssal scavengers, juvenile lutjanids, the fate of bycatch discards, and the densities of carnivorous fish inside and outside marine protected areas (see Cappo *et al.* 2007a for review). It has been chosen elsewhere in tropical northern Australia to overcome the limits to UVC imposed by turbidity inshore (Gomelyuk 2009) for standardised surveys of fish biodiversity (Cappo *et al.* 2007b; Watson *et al.* 2008).

In this rapid assessment we applied a fleet of eight replicate BRUVS (Baited Remote Underwater Video Stations) simultaneously to describe the spatial patterns of species richness and assemblage structure of the ichthyofauna in the vicinity of James Price Point. Our main aim in this paper was to analyse the responses of species occurrence at each sampling site to the depth, position and epibenthic cover of key groups of marine plants and filter feeders. Our secondary aims were to analyse the effect of underwater visibility on the number of species recorded by the baited video technique, and to compare the local indices of diversity and abundance with the same measurements recorded from similar habitats by BRUVS in the Great Barrier Reef lagoon.

## Methods

### Survey design

The survey region was a ~30km x 14km (~420km<sup>2</sup>) stretch of sub-tidal coastal shelf extending from 17.7° – 17.3° South, from the 5m Lowest Astronomical Tide (LAT) isobath, seaward to 122.03° East. The study area was generally less than 20 metres (LAT) in depth (Figure 1). This area encompassed spatial gradients and contained habitat gradients and strata identified in previous studies (Fry *et al.* 2008). The survey employed a spatially interspersed design that aimed to sample habitats in proportion to their availability, thus enabling differences amongst habitats to be estimated robustly. The specified survey area was divided into 160 equal sized units and excluded the local pearl farm leases. Within each unit random coordinates were determined for BRUVS placement, conditional on the sampling point being >450m from the nearest neighbouring BRUVS deployment. Most species were unlikely to move this distance in the short period between consecutive deployments (see Cappo *et al.* 2004). BRUVS were deployed in latitudinal blocks of 32, and each block was

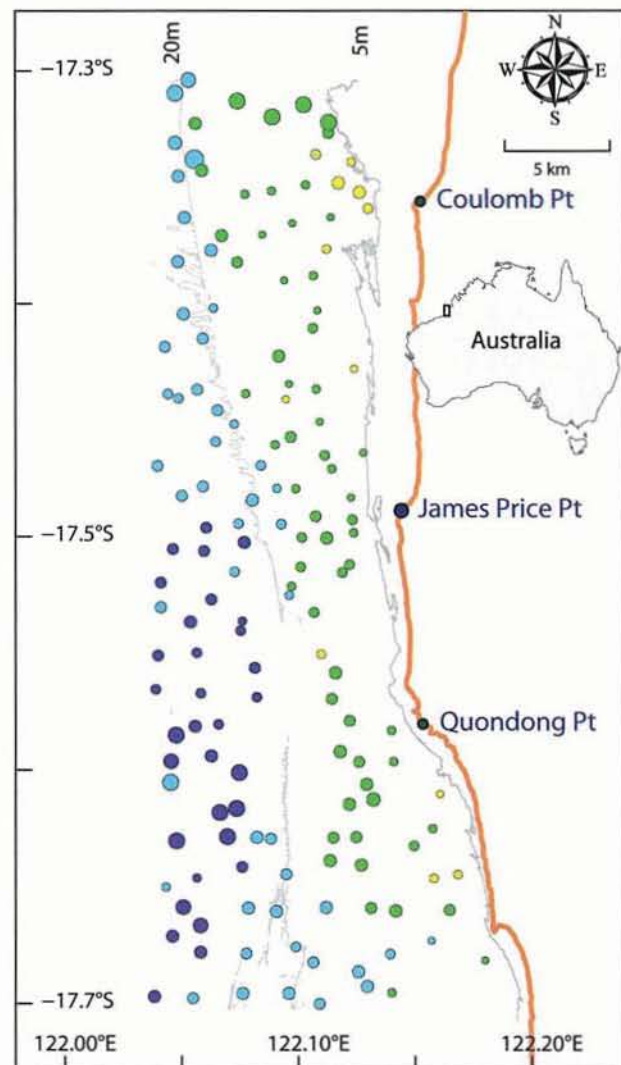

**Figure 1.** The location of 154 successful BRUVS deployments. The 5m and 20m depth contours at lowest astronomical tide (LAT) are shown offshore from the coast. The size of site symbols has been scaled by estimates of underwater visibility. The colour ramp from yellow to blue represents increments of 6 metres depth recorded at the time of BRUVS drops. James Price Point, Coulomb Point and Quondong Point are shown on the coastline.

sampled in a single day. Fleets of 8 BRUVS were deployed at a time, with fleets interspersed over the latitudinal and longitudinal gradient of the block to avoid temporal confounding with tidal movement. All sampling was carried out around the neap tides of 11–15 October 2009.

### BRUVS deployments and tape interrogation

The BRUVS consisted of a galvanised steel frame onto which a camera housing, bait arm, ballast weights, ropes and floats were attached (see Fig. 2). A Sony MiniDV tape "Handicam" was used to film through an acrylic port within a PVC underwater housing, pressure-rated to depths of 100m. A flexible bait arm held a plastic mesh bait bag containing 1 kg of minced pilchards (*Sardinops sagax neopilchardus*) at a distance of approximately 1.5 m in front of the camera lens. The bait bag lay on the seabed



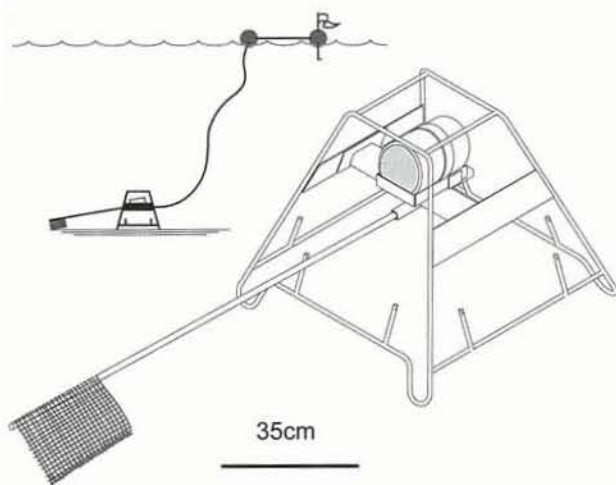

Figure 2. The AIMS BRUVS assembly.

in the field of view, with the camera tilted downwards at an angle of 10 degrees.

The AIMS BRUVS2.5.mdb<sup>®</sup> database provided an interface with a video playback device to capture time codes and still images and to store and record data. The interface allowed for standardised identification and quantification of habitat types and fish numbers in the immediate field of view, the timing of events and comparison of video frames with a library of reference images. The relative abundance of vertebrates in the video footage was estimated by *MaxN*, defined by the maximum number of each species visible at any single point on the tape. The use of this conservative metric was reviewed by Cappo *et al.* (2003).

The percentage cover of abiotic substratum types and biotic habitat types in the field of view was estimated from still images captured as soon as the BRUVS settled on the seafloor. The categories in terms of substratum type were sand, gravel, rubble, calcareous reef, indeterminate, boulder, and bedrock. The seven categories scored for epibenthic cover were none, seagrass, macroalgae, sea whips, soft corals, sponges, and gorgonian sea fans with each component estimated to the nearest 10 percent. Underwater visibility was estimated subjectively to the nearest metre when viewing the BRUVS tapes.

### Statistical analyses

The partial effects of depth, total epibenthic cover, longitude, latitude and underwater visibility on species richness were investigated using aggregated boosted regression trees (abt; see De'ath 2007, Elith *et al.* 2008). Boosted regression trees are a statistical learning method that optimises both the explanatory and predictive power of regression and classification analyses. Non-linear interactions between predictors were quantified and visualised using partial effects plots. Generalized additive models (gam) based on spatial position alone were used to develop a smoothing function for species richness (see Venables & Ripley 2002). Contour plots of the model fits were overlain with symbols scaled to the observed levels of total epibenthic cover at each BRUVS site. Boxplots of the medians in the number of

species, genera, families and individuals were compared between the James Price Point dataset and a subset of the BRUVS data for the Great Barrier Reef (GBR) lagoon (see Cappo *et al.* 2007b). This subset of 142 samples in the GBR lagoon was selected for similarity to the James Price Point study area in terms of distance from shore (< 15.45 kilometres) and depth (< 24.4 metres).

No species occurred at all sites, so use of presence-absence data alone was used to amplify the contribution to models of common species with low abundance. Multivariate responses at each BRUVS site, in the form of the occurrence of a subset of the 59 most prevalent species (occurring at more than 4 sites), to a relatively large number of environmental covariates were defined with a redundancy analysis (rda; Borcard *et al.* 2011) and multivariate regression trees (MRT; see De'ath 2002). The explanatory covariates included the percentage cover of sediment types and categories of epibenthos described above. Centring of the species by site response matrix was done for the redundancy analysis by subtracting the column means of each species from their corresponding columns, and scaling was done by dividing the (centred) columns of each species by their root-mean-square.

Indicator values (DLI; Dufrêne & Legendre 1997) were calculated for each species for each assemblage (nodes and terminal leaves) identified in the MRT. For a given species and a given group of BRUVS sites, the DLI was defined as the product of the mean species prevalence occurring in the group divided by the sum of the mean prevalence in all other groups (specificity), times the proportion of sites within the group where the species occurs (fidelity), multiplied by 100. The DLI has a maximum value of 100 if the species occurs at all sites in the group and nowhere else. Each species can be associated with the tree node (assemblage) where its maximum DLI value occurred. Species with high DLI can be used as characteristic representatives of each assemblage, and the spatial extent of the group indicated the region near James Price Point where the assemblage was predominantly found. Species accumulation curves (SAC) were used to record the rate at which new species (*y*) were added with continued sampling effort (*x*) in each assemblage identified by the MRT (see Gotelli & Colwell 2001; Thompson *et al.* 2003). The analyses used the open-source R statistical package (R Development Core Team 2006) with the libraries of De'ath (2007). The use of common and scientific names follows those reported in Allen & Swainston (1988).

## Results

### Habitat types and their distribution

There were three major regions of cross-shelf zonation in the study area proximal to each of the coastal points (Figure 3). The cross-shelf zone off Coulomb Point in the north was comprised of mixed patches of bare ground and beds of marine plants and filter-feeders, and some BRUVS landed in seagrass beds inshore. There was a broad band of bare sand extending offshore from James Price Point. Off Quondong Point there was a sandy coastal bench inshore of a ridge of high diversity and abundance of epibenthos parallel to the 20m depth



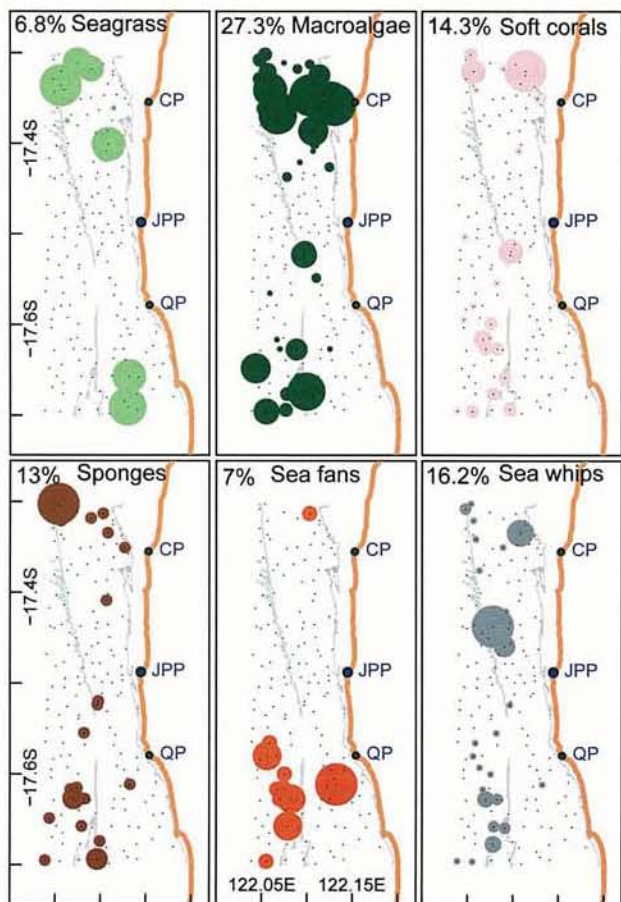
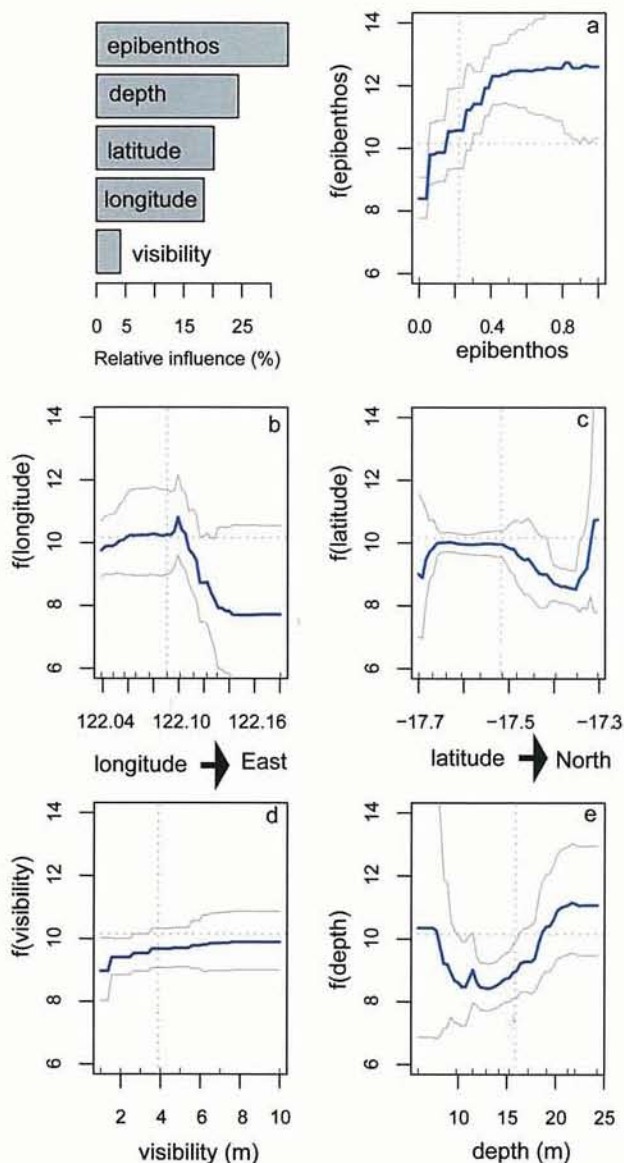

**Figure 3.** The percentage cover of epibenthos at all BRUVS sites by category, showing the percentage of sites where each category was recorded. Bubbles are scaled to the maximum percentage cover recorded within each category.

contour. Marine plants and filter-feeding sponges, gorgonian fans, and soft corals had increased levels of epibenthic cover in the northern and southern parts of the study area. The bare sandy habitats were physically structured into sand ripples in shallow waters, and low dunes in deeper waters.

Sea whips were found mainly in the south in a line parallel to the 20m depth contour. Along this line there was clear evidence of a low ridge of exposed bedrock, or a long-shelf band of coarser sediment, that supported the attachment of holdfasts by filter-feeders. A similar linear pattern in the south was seen for the sponges and soft corals. Seagrasses were not a common feature of the epibenthos in the BRUVS sets, and were most abundant in the shallows of the north and south between the 5m and 20m depth contours. Macroalgae were more widespread, on 27.3% of BRUVS sets, but were most abundant in the north and south in co-occurrence with filter-feeders.

The entire study area was shallow, with all samples <25 metres, so benthic irradiance was sufficient to allow macroalgae and filter-feeders to occur together in dense patches on some BRUVS sites where bedrock or consolidated gravel was present. No hard corals were seen on BRUVS sets, and the major "reefal" habitats were comprised of mixed beds of macroalgae and filter-feeders



**Figure 4.** Relative variable importance plot and partial dependency plots for boosted tree analyses of the species richness data. The importance plot shows their relative contributions (%) to predicting species richness, and the five partial plots show the dependencies of richness on epibenthic cover (a), longitude (b), latitude (c), underwater visibility (d) and water depth (e). The gray lines show 95% confidence intervals. The distribution of values of the predictor variables is indicated by tick marks above the x-axes, showing deciles. Dotted vertical lines indicate the mean value for each predictor, and horizontal lines show the mean species richness in the entire dataset (10.15).

on harder seafloors of low topographic relief. Larger rocks and boulders were not seen, and the bare sandy habitats were arranged in ripples, indicating that the subtidal substratum was being heavily scoured and redistributed by both Indian Ocean swells and the 8 metre tidal range. Habitats supporting stony corals, or dominated by them, have been reported to occur on the inshore margin of the study area (Fry *et al.* 2008), but they were too shallow or turbid to be accessed by the BRUVS survey vessel.



### The fauna

A total of 7108 individuals from 116 species of fishes, sharks, rays and seasnakes were recorded from the 154 sites. Bony fishes were represented by 8 orders, and dominated by perch-like fishes (Perciformes 79 species), whilst cartilaginous fishes were well represented by 19 species from three orders. There were also two species of sea snakes from the family Hydrophiidae (Appendix 1). Only three species were considered to be endemic to Western Australia – the frostback cod *Epinephelus bilobatus*, the western butterflyfish *Pentapodus vitta* and the blue-spotted tuskfish *Choerodon cauteroma* (Hutchins 2001). The top 20 species are shown in Table 1. A wide range of functional groups was present in this fauna, although herbivores were rare and the predominant groups were carnivores that feed either on the seafloor or in the water column, and mobile predators of nekton and zooplankton.

### Effects of visibility, position and epibenthic cover on species richness

The partial effects plots in Figure 4 show that there was a marginal, non-significant effect of underwater visibility on the performance of BRUVS. On average there were 10.15 species identified in each sample, but over a 9 metre range in visibility there was a diminution of only 1 species less than this average. The response was non-linear, with the drop in performance only at the lowest visibility (~1 metre). The total amount of epibenthic cover was the most important influence on species richness in the model, accounting for 34% of the variation explained. Depth (24%), latitude (20%) and longitude (18%) were also important, but underwater visibility accounted for only 6% of the variation explained (Fig. 4).

All sites where epibenthic cover was above average (~20%) had species richness above the mean, but this flattened off at 2 extra species for sites with epibenthic cover >40%. The partial effects of longitude were sigmoidal, with species richness declining towards shore in the eastern half of the study area. Richness initially declined in the northern half of the study area, but then rose above the average at the northern boundary. Richness fell to a minimum about 10–14 metres depth, but rose to above average levels in water deeper than 20 metres.

Contour plots showed that the model of species richness predicted by position (latitude and longitude) alone did not strictly follow the total abundance of epibenthic structure on the seabed (Fig. 5). However, there were two coarse groups of sites with both high richness and more habitat complexity to the north and south of James Price Point. A long-shore belt of lower diversity (<8 species) extended from the south up to James Price Point and then spread offshore into a broad zone with 8–10 species. The zones of highest diversity in the south and north had species richness >14, which appeared to be increasing above 18 along the northern boundary of the study area (Fig. 5).

### Comparison with the GBR lagoon

The significant lack of overlap in the 95% confidence intervals for the medians (notches) in Figure 6 show that the ichthyofauna in the James Price Point study area had much higher diversity and abundance compared to BRUVS samples from equivalent positions in the GBR lagoon. The medians differed significantly by a factor of 2 for richness, 1.8 for the number of genera, 1.75 for the number of families and 2.8 for fish abundance (Fig. 6). The median number of orders (1) was the same for each area. The ratio of mean values for fish abundance (2.01) and richness of species (1.74), genera (1.76), families (1.58) and orders (1.15) also indicated strong differences.

Table 1

The top 20 species sighted on BRUVS, in descending order of occurrence (presence/absence) on 154 BRUVS sets in the study area off James Price Point. The percentage contribution of each species to the overall data set ( $\Sigma\Sigma MaxN = 7108$  individuals) is shown in terms of numbers counted and prevalence on BRUVS sets (%occ). The relative rank\* in the stereo-BRUVS data from Burrup Peninsula (Watson *et al.* 2008) is also shown.

Family	Common Name	Species	% $\Sigma\Sigma MaxN$	%occ	rank*
Scombridae	School mackerel	<i>Scomberomorus queenslandicus</i>	4.6	89.6	1
Nemipteridae	False whiptail	<i>Pentapodus porosus</i>	15.2	77.3	3
Carangidae	Smooth-tailed trevally	<i>Selaroides leptolepis</i>	18.9	70.8	–
Carangidae	Yellowtail scad	<i>Atule mate</i>	15.6	55.8	–
Carangidae	Bumpnose trevally	<i>Carangoides hedlandensis</i>	1.3	34.4	–
Lethrinidae	Blue-spotted emperor	<i>Lethrinus punctulatus</i>	7.3	33.1	10
Carangidae	Golden trevally	<i>Gnathanodon speciosus</i>	2.4	29.2	–
Leiognathidae	Smithurst's ponyfish	<i>Leiognathus longispinis</i>	4.6	26	–
Lutjanidae	Stripey seaperch	<i>Lutjanus carponotatus</i>	1.3	26	12
Pinguipedidae	Red-banded grubfish	<i>Parapercis multiplacata</i>	1	24.7	–
Carangidae	Goldspot trevally	<i>Carangoides fulvoguttatus</i>	0.8	22.7	9
Nemipteridae	Rosy threadfin bream	<i>Nemipterus furcosus</i>	2.4	21.4	–
Pomacanthidae	Scribbled angelfish	<i>Chaetodontoplus duboulayi</i>	0.7	21.4	8
Carcharhinidae	Aust. blacktip shark	<i>Carcharhinus tilstoni</i>	0.5	20.8	–
Echeneidae	Suckerfish	<i>Echeneis naucrates</i>	0.6	20.1	9
Serranidae	Frostback cod	<i>Epinephelus bilobatus</i>	0.6	19.5	11
Carangidae	Queenfish	<i>Scomberoides commersonnianus</i>	0.4	18.8	–
Nemipteridae	Western butterflyfish	<i>Pentapodus vitta</i>	1	18.2	–
Labridae	Purple tuskfish	<i>Choerodon cephalotes</i>	0.6	18.2	–
Labridae	Bluespotted tuskfish	<i>Choerodon cauteroma</i>	0.5	17.5	4



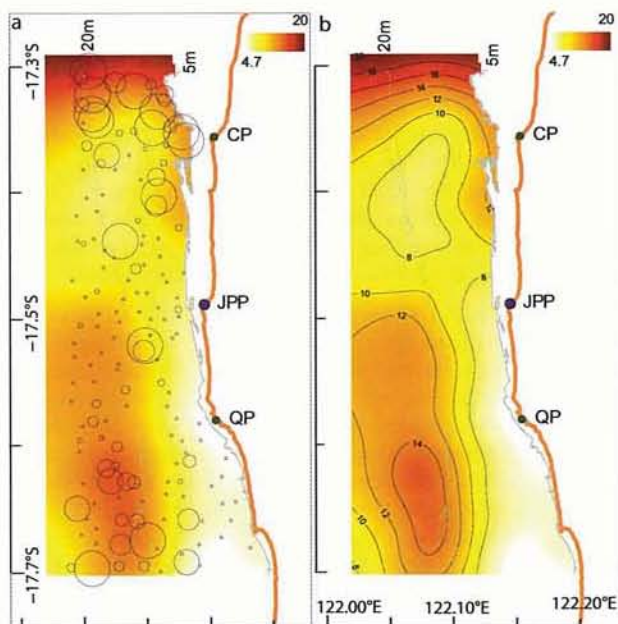
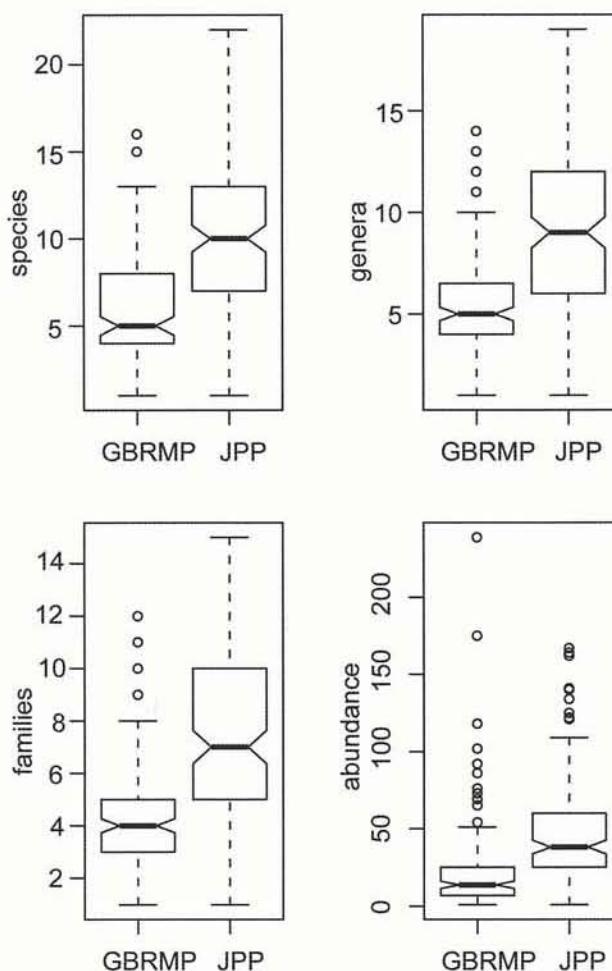

**Figure 5.** Smoothed spline fits (gam) of the total number of species recorded at BRUVS sites. Site symbols on panel (a) are scaled to the amount of epibenthos of all categories (summed percentage cover) seen in the field of view. Diversity contours (b) and the colour ramp show that richness predicted by position alone did not strictly follow the abundance of epibenthic structure on the seabed, although there were two groups of sites with both high richness and more habitat complexity to the north and south of James Price Point (JPP). Coulomb Point (CP) and Quondong Point (QP) are also shown on the coastline.

#### Associations between fishes and habitats

All environmental and spatial variables were significant in a redundancy analysis using constrained eigenvalues, and the model explained about 19% of the total variation in the species occurrence at each BRUVS site (Fig. 7). The first axis accounted for 47.6% of the total variation (19%) explained by all the axes in the model, indicating that BRUVS sites were separated first by the amount, or absence, of epibenthos, and then (on the second axis) by depth and latitude. Deeper sandy sites were separated from shallower sandy sites along this axis, as were the northern “garden” seafloors where macroalgae and seagrass were more abundant in the shallower water. Sponges, gorgonian fans and sea whips were more abundant in the southern, deeper parts of the study area.

The site symbols in the biplots of Figure (7) are coloured by their membership of the four vertebrate assemblages distinguished in the MRT analysis described below. The linear combination scores for sites on the biplots showed that bare, sandy habitats were located on gradients of both depth and latitude. The deeper “southern gardens” encompassed more filter feeding epibenthos, and the “northern gardens” included more habitats dominated by macroalgae and seagrass. The biplots showed that the ichthyofauna was broadly organized into three groups on the first two dimensions: (1) ubiquitous, generalist species that were either independent of, or in some cases negatively associated with, biotic habitat; (2) species that were associated with



**Figure 6.** Comparisons of the median richness of species (a), genera (b), families (c), and fish abundance ( $\Sigma MaxN$ ) (d) recorded by  $n=142$  BRUVS in the Great Barrier Reef Marine Park (GBRMP) and  $n=154$  BRUVS in the current study (JPP). The boxplots show the median and 95% Confidence Intervals. The notches represent  $1.5 \times$  (interquartile range of  $\Sigma MaxN / \text{SQRT}(n)$ ). If the notches do not overlap this is strong evidence that the two medians differ, independent of any assumptions about normality of data distributions or equivalence of variances (Chambers *et al.* 1983).

vegetated habitats, and (3) species that were associated with filter-feeding epibenthos. There was no evidence of strict associations between particular species and particular types of epibenthos. For example, the “northern gardens” sites were inhabited by more purple tuskfish *Choerodon cephalotes* and blue-spotted emperor *Lethrinus punctulatus*, but they were not restricted to these sites.

#### Assemblage-level patterns in fish-habitat associations

At the third and final split in the multivariate regression tree of the same responses and explanatory variables described above, the MRT had explained 16.3% of the species variation (Fig. 8). The first split in the tree, based on low levels of bare sediment, explained 9.5% of the species variation, whereas the next split (depth < 18m) explained 4.5% of variation, and the final split (latitude < -17.40°S) accounted for 2.3%. An examination of the



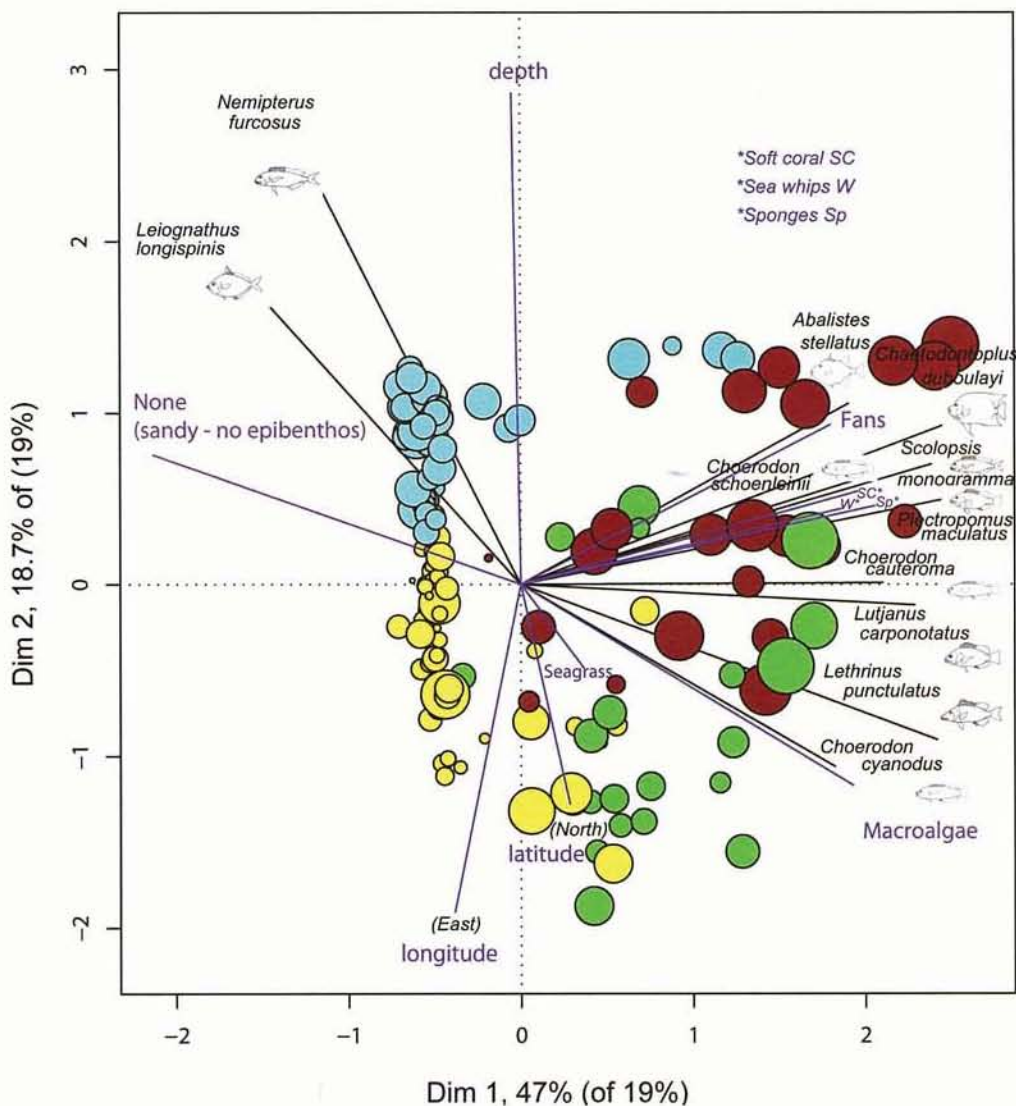

**Figure 7.** Biplot scaled by species scores from a redundancy analysis of the occurrence (presence/absence) of the 59 most prevalent species constrained by position, depth and percentage cover of the seafloor by epiflora and epifauna. Only the longest 20% of species vectors are shown. The fitted scores (linear combinations of constraining variables) for each BRUVS site are coloured by their membership of four fish assemblages identified by multivariate regression trees (see Figure 8). The assemblages are “deep sandy” (light blue), “shallow sandy” (yellow), “northern gardens” (light green) and “southern gardens” (brown). The symbols are scaled by the species richness (divided by 4) at each site.

surrogates at the first split showed that “none” improved the model by 9.5%, in competition with 7.1% for “macroalgae” and 5.0 – 5.9% for “sea whips”, “sponges”, and “soft coral”. This occurred because the categories of seafloor cover were complementary, so that (100-“none”) represents the amount (percentage cover) of epibenthos of all categories in the field of view.

At the second split, the nearest surrogate for depth < 18m (improving the model by 7.5%) was longitude < 122.084° E, which improved the model by 5.9%. The study area lay in a north-south alignment and depth varied across the shelf with contours parallel to the coast. Thus it was not surprising that longitude was a close surrogate for depth. At the final split, based on latitude < -17.40 °S, the nearest surrogate was depth < 15.45 metres. The spread of the depth contours offshore from the coastline to the north of James Price Point show

the shallower waters there (see Fig. 1). In fact, all the deepest BRUVS sites were located to the south of James Price Point (about -17.49°S). The species richness and abundance of all species sighted at sites in the “shallow sandy”, “deep sandy”, shallow “northern gardens” and deeper “southern gardens” are shown in Table 2. Richness appeared to increase with depth amongst the assemblages of both “bare” and “garden” types. The location of sites within these assemblages is shown in Figure 9.

#### *Species indicators for local assemblages*

The top 10 Dufrene-Legendre Indices (species DLI) are shown for each node and terminal “leaf” of the tree in Figure 8. The tree is hierarchical, so species that were ubiquitous in the study area, such as the school mackerel *Scomberomorus queenslandicus*, were located at the tree

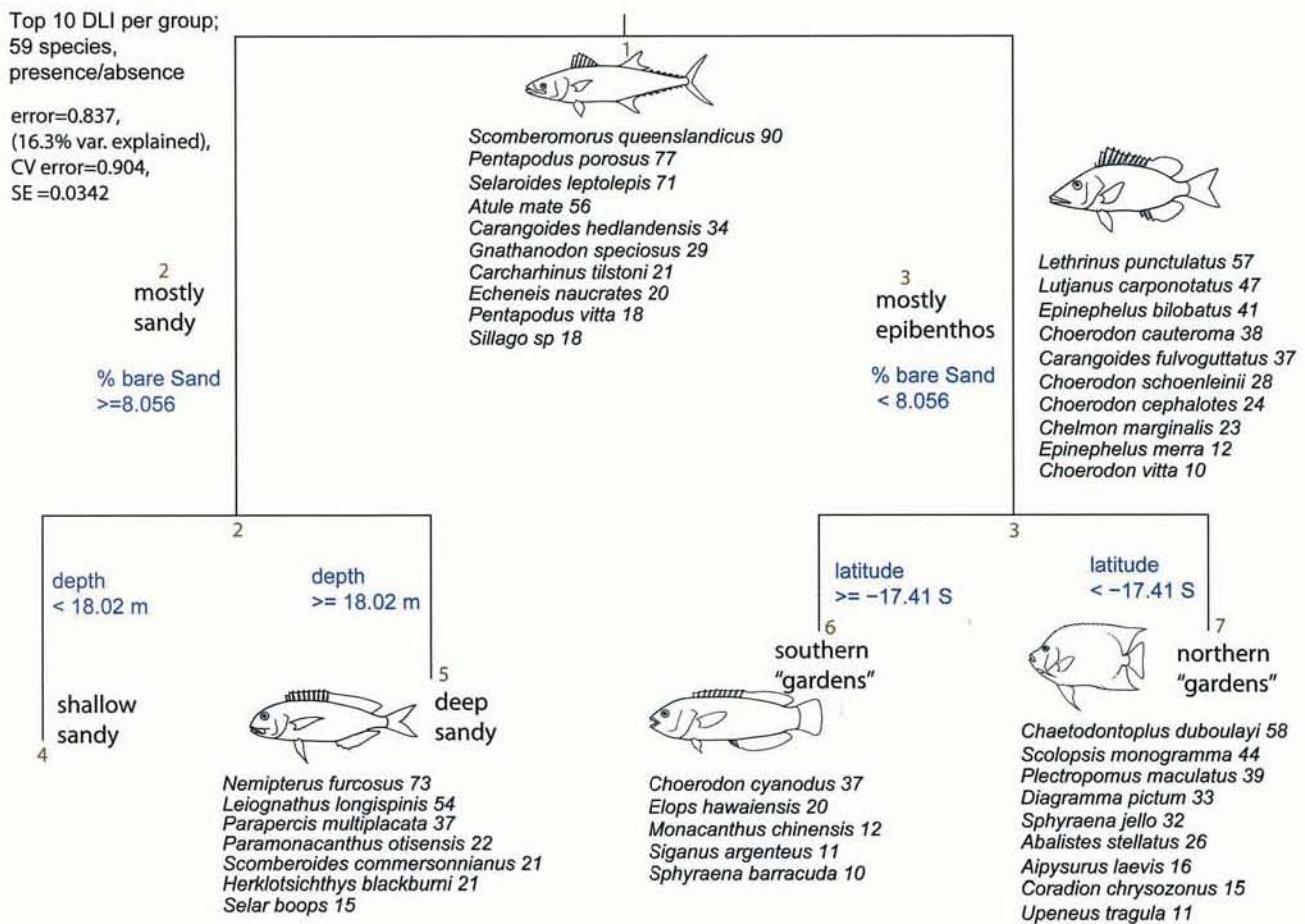

**Figure 8.** Multivariate regression tree (MRT) analysis of the occurrence of the 59 most prevalent species. This model explained 14% of the variation of these 59 species in response to position, depth and epibenthic "cover". Species at the stump were ubiquitous. The top 10 Dufrêne-Legendre Indices (species DLI) are shown for each node. Some nodes and leaves had no DLI, because species that occurred there also occurred elsewhere in the tree with higher fidelity and specificity.

stump. A list of others known to inhabit many types of rugose habitats (e.g. *Lethrinus*, *Lutjanus*, *Choerodon*, *Epinephelus*) characterised the "epibenthos" node, on the side of the tree where the leaves were the deep southern grounds and the shallow northern beds.

On the other side of the tree the bare seafloor habitats were distinguished by indicator species only in the deeper waters. The "shallow sandy" assemblage had no DLI, because the numerous species that occurred there also occurred elsewhere with higher frequency. The

species accumulation curves in Figure 10 show that the shallow sandy assemblage was the most diverse, yet it had no DLI indicator species. This implied that many species occurred there, but they were more prevalent at other nodes and leaves of the tree. The assemblages characterised by the cover of epibenthos comprised relatively few sites (< 23 sites each) and showed no sign of reaching an asymptote – indicating that there remained much latent diversity to be sampled in those assemblages.

**Table 2**

Summaries of the abundance ( $\Sigma MaxN$ ) ( $N$ ) and richness ( $S$ ) of all the 116 species from sites included in each assemblage identified from the distribution of 59 more prevalent species in Figure 6.

n BRUVS	assemblage	$\Sigma$ richness ( $S$ )	$\Sigma MaxN$ ( $N$ )	$S$ range	$S$ mean	$N$ range	$N$ mean
69	Shallow Sandy	77	2044	(1 – 19)	(7.1 ± 3.9)	(1 – 102)	(29.6 ± 21.8)
43	Deep Sandy	66	2855	(7 – 18)	(11.3 ± 2.7)	(21 – 167)	(66.4 ± 38.2)
20	Nthn Gardens	65	956	(8 – 22)	(12.5 ± 4.2)	(15 – 88)	(47.8 ± 19.8)
22	Sthn Gardens	66	1253	(3 – 22)	(15.2 ± 4.7)	(4 – 141)	(57 ± 36.8)



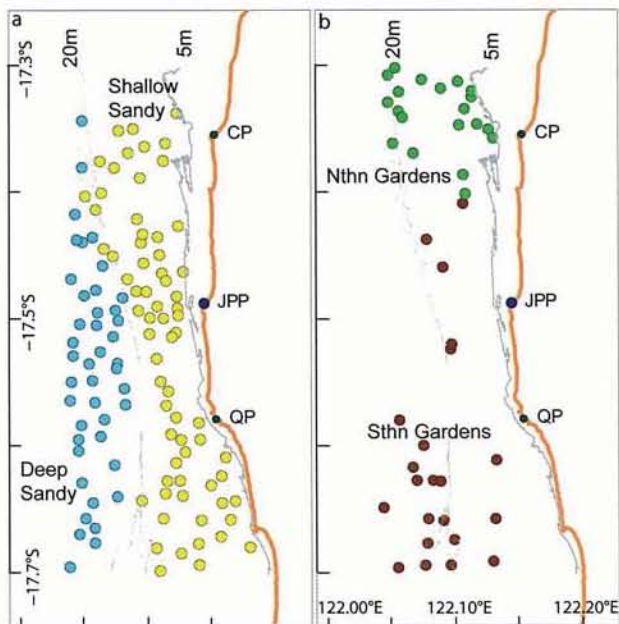
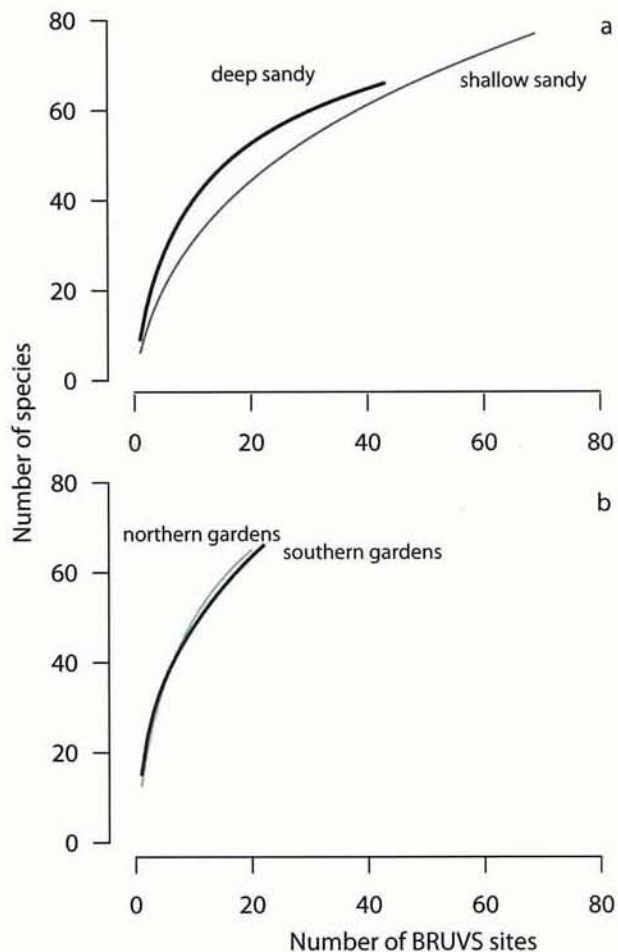

**Figure 9.** Location of sites in the four vertebrate assemblages distinguished by the multivariate regression tree (MRT) analysis in Figure 8. The shallow and deep “bare sandy” assemblages were separated near the 20m [LAT] depth contour, where wave action at the seabed is generally diminished. The sites where epibenthic cover (of marine plants and/or filter-feeders) was greater than 90% formed northern and southern groups.

## Discussion

The results presented here show that the ichthyofauna around James Price Point was diverse and abundant, given the shallow depth, lack of rugose seafloor topography and lack of sub-tidal coral reefs in the area sampled. The diversity and abundance of large, predatory, vertebrates so close to shore in relatively shallow water was remarkable in comparison to similar seascapes from the Great Barrier Reef lagoon (Cappo *et al.* 2007b) and Burrup Peninsula (Watson *et al.* 2008). The abundance of small pelagic “baitfish” (such as clupeid sardines, yellowtail scads and smooth-tailed trevally) was accompanied by a correspondingly high occurrence and abundance of schooling, predatory carangid trevallies and scombrid mackerels known to include fish in their diets. Apex predators including large sphyraenid barracudas, and carcharhinid (whalers) and sphyrnid (hammerhead) sharks, were common.

There were three major regions of cross-shelf zonation in the study area proximal to each of the coastal points. The species richness showed two coarse groups of sites with both high richness and more habitat complexity to the north and south of James Price Point. A long-shore belt of lower richness extended from the south up to James Price Point and then spread offshore into a broad sandy zone. The zones of highest richness in the south and north had more than 14 species, increasing beyond 18 species along the northern boundary of the study area. Underwater visibility had very low influence on the number of species sighted on the BRUVS, giving us confidence that this technique will be useful in macrotidal tropical areas when sampling on neap tides. It is probable that tidal scouring removes much of the



**Figure 10.** Species rarefaction curves for the four vertebrate assemblages distinguished by the multivariate regression tree (MRT) analysis of the presence/absence of 59 species. The shallow sandy assemblage was the most diverse, yet it had no DLI indicator species. The assemblages in epibenthic “gardens” showed no sign of reaching an asymptote – indicating that there remained much latent diversity in those assemblages. More sampling would be needed to adequately measure that latent diversity.

fine silt from the inshore sediments, so that suspended solids settle quickly when tidal movement ceases.

The most parsimonious model of assemblage structure constrained by depth, position and nature of the epibenthos separated BRUVS sites in the “shallow sandy”, “deep sandy”, shallow “northern gardens” and deeper “southern gardens”. Diversity appeared to increase with depth amongst the assemblages of both “bare” and “garden” types. This may well indicate the presence of an interaction between depth and sediment composition, or sediment grain size, in defining fish assemblages. Analysis of the Dufrene-Legendre Indices (species DLI) for each assemblage showed that epibenthos in both the north and south were characterised by the labrid tuskfishes, lethrinid emperors, lutjanid snappers and serranid cods known to inhabit rugose topography elsewhere (Travers *et al.* 2006, Cappo *et al.* 2007b). For example, painted sweetlips (*Diagramma*), coral trout (*Plectropomus*), angelfish (*Chaetodontoplus*) and



triggerfish (*Abalistes*) characterised the deeper (~20m) southern ridge of epibenthos north of Quondong Point. The “deep sandy” assemblage, which intruded inshore to James Price Point, was characterised by ponyfish (*Leiognathus*), threadfin bream (*Nemipterus*) and queenfish (*Scomberoides*).

The assemblage structure indentified here reflected the functional form and habitat preferences of the fauna, so that some demersal carnivores were associated more with epibenthos in the north and south than with bare sandy substrata, and the most prevalent species were ubiquitous throughout the study area in all the habitat types sampled. These same prevalent species (the school mackerel *Scomberomorus queenslandicus* and the false whiptail *Pentapodus porosus*) were in the top three species sighted on stereo-BRUVS deployed off the Burrup Peninsula by Watson *et al.* (2008). Like estuarine fish faunas (Magurran & Henderson 2003), the ichthyofauna comprised ‘core species’, which are persistent, abundant and biologically associated with particular habitats, and ‘occasional species’ which occur infrequently in surveys, are typically low in abundance and have different habitat requirements. Species accumulation curves for such assemblages are generally long and high (Thompson & Withers 2003) with many samples needed to obtain comprehensive species lists.

Macroalgae and filter-feeders co-occurred in beds (or banks) where the waters were shallow enough to allow photosynthesis to occur. As expected for such mixed habitats, benthic macro-carnivores (*e.g.* wrasses, emperors and snappers) were common. Such groups prey on infauna, epifauna, natant crustacea, and benthopelagic cephalopods. Tuskfishes of the genus *Choerodon* were also expected to occur there because they have similar broad range in diet, but they also have specialised dentition and massive jaw muscles that enable them to grasp and wrench off hard-shelled prey, such as limpets and gastropods, from hard substrata. Habitats supporting marine plants such as fleshy macroalgae and seagrasses are also known to provide nursery sites for lethrinid emperors (Wilson 1998, Nakamura *et al.* 2009) as well as the foundations of food chains based on grazers and detrital pools.

The plectorhynchid *Diagramma* recorded in the study area is also well known to inhabit megabenthos patches in the Indo-Pacific and feeds by suction and sifting of pockets of finer sediment (Cappo 2010). The whiting *Sillago* sp, ponyfish *Leiognathus longispinis* and threadfin bream *Nemipterus furcosus* associated with bare sandy sediments are known to consume infauna and small natant crustaceans. Slow-moving balistids, monacanthids and tetraodontids were also prevalent in the study area. These three families have teeth fused into very powerful cutting plates that allow them to eat a wide variety of plant and animal food sources, such as sponges, echinoderms and heavily-armoured decapods and sedentary fish. The tetraodontiformes employ toxins, armature and behavioural defences that allow them to occupy a wide variety of niches where there is no shelter from larger predators.

Quantitative comparisons between studies within the Kimberley region using BRUVS, UVC (Hutchins 2001), traps and trawls (Travers *et al.* 2006, 2010) cannot be made because of the different selectivity of each

technique that applies a “filter” to the view of the fish community (see Cappo *et al.* 2004 for review). However, broad contrasts with Area 17 (Broome to Cape Leveque) in Hutchins (2001) and the Canning bioregion (Travers *et al.* 2006, 2010) showed a much higher proportion of mobile, demersal, pelagic and semi-demersal predators in the James Price Point study area – and a lack of small sedentary and cryptic species. This must presumably be a result of the lack of coral reefs in the area sampled off James Price Point, the inability of the BRUVS to record smaller cryptic or nocturnal fishes (such as flatfishes), and the inability of traps and trawls to catch the larger ones (such as sharks).

Stereo-BRUVS were used by Watson *et al.* (2008) on the Burrup Peninsula in a different biogeographical region, but some robust comparisons can be made. Firstly, there were some notable similarities in the fauna seen in the two studies. Nine of the top 20 species seen off James Price Point were in the top 20 species recorded by Watson *et al.* (2008). Species such as the school mackerel *Scomberomorus queenslandicus*, false whiptail *Pentapodus porosus* and stripey seaperch *Lutjanus carponotatus* were broadly similar in their importance in both studies. Secondly, the James Price Point study area had a much higher abundance of “small pelagic” trevallies (*Selaroides*, *Atule*) and “large semi-demersal” predators (*Gnathanodon* trevallies, *Carcharhinus* sharks, *Scomberoides* queenfish), leiognathid ponyfish and nemipterid threadfin breams that inhabit bare substrata.

There were also some strong differences, with banded grunter *Terapon theraps* and caesionid fusiliers absent from James Price Point, and scarid parrotfish rarely recorded. The caesionid fusiliers are known to inhabit reefs dominated by corals, and the banded grunter prefer muddy/silty seafloors absent from the highly-scoured region off James Price Point (Cappo *et al.* 2007b). The lack of scarid parrotfishes was more likely due to the types of habitat sampled rather than a bias introduced by the BRUVS sampling technique. Field tests have shown that the use of bait produces much better discrimination of spatial groups, including herbivores, corallivores and other functional groups (Harvey *et al.* 2007, Cappo 2010), and Watson *et al.* (2008) recorded scarids on BRUVS in the Burrup peninsular.

There were also some important similarities amongst the associations between fishes and habitat detected in the two regions. Watson *et al.* (2008) found that fish assemblages were mainly distinguished between “bare” habitats and those with “epibenthos”. Five types of substrata were recognised in that study (reef, sand-inundated reef, silty sand, coarse sand, reef/sand interface) and four of them had a significant relationship with the assemblage structure of fishes. Approximately 70% of the fish assemblage in silty and coarse sand areas comprised individuals in the families Terapontidae, Carangidae, Caesionidae and Nemipteridae. The “reef fish” assemblages included lethrinid emperors, lutjanid snappers and serranid cods. Approximately 70% of the assemblage in reef areas comprised individuals in the families Caesionidae, Nemipteridae, Carangidae, Labridae, Lethrinidae and Lutjanidae.

Sponge “gardens” and “macroalgae” were also recognised by Watson *et al.* (2008) in their analyses of stereo-BRUVS footage. Associations of fish with these



habitats were strongest for the coverage of algae, most notably for the redstripe tuskfish *Choerodon vitta*, the spangled emperor *Lethrinus nebulosus*, the bar-tailed goatfish *Upeneus tragula*, the grubfish *Parapercis xanthozona* and the palenose parrotfish *Scarus psittacus*. Numerous species were more abundant in habitats of the Burrup Peninsula dominated by stony corals and turf algae, especially black-tipped cod *Epinephelus fasciatus*, stripey seaperch *Lutjanus carponotatus*, monocle bream *Scolopsis monogramma*, moon wrasse *Thalassoma lunare* and ring-tailed surgeonfish *Acanthurus grammoptilus*. It is likely that some of these species inhabit the coral-dominated fringing reefs that were inaccessible to BRUVS in the James Price Point study area.

In summary, the simultaneous visual sampling of fish and their habitats has provided a baseline for predicting, monitoring and managing impacts on the ichthyofauna off James Price Point as well as adding to the understanding of the biodiversity of the poorly-known Kimberley region. The study area can be visualised in terms of latitude by deeper and shallower "garden" habitats, and by longitude, or cross-shelf increase in depth. Perhaps the simplest seafloor topography of all, the bare sandy habitat, intrudes inshore to James Price Point. The patterns in the fauna follow the distribution of species and assemblages known to occur elsewhere in the Indo-Pacific, but were most notable for the abundance of small planktivores and large predators. Comparison with the fauna at similar distance to shore in similar latitudes in the Great Barrier Reef lagoon showed significantly higher indices of diversity. In comparison with the Burrup Peninsula there were more small pelagic planktivores and more large semi-demersal predators. There was also an absence of some species normally associated with muddy seafloors (*e.g.* teraponid grunters) and fringing coral reefs (*e.g.* caesionid fusiliers and scarid parrotfish) that are common on BRUVS set elsewhere in regions with less extreme tidal ranges. It is possible that the baitfish-predator assemblages were enhanced by a higher nutrient status of north-western waters due to the Indonesian through-flow, tidal re-suspension and episodic upwellings offshore – but data is lacking. A lack of intense fishing pressure may also play a role. A multivariate analysis including the stereo-BRUVS data collected by Watson *et al.* (2008) from the Burrup Peninsula would enable much better interpretation of the faunal patterns recorded here for the James Price Point study area.

**Acknowledgements:** We gratefully acknowledge the provision of custom R libraries by Dr G. De'ath and the assistance provided by the master and crew of MV "Browse Express". This work was commissioned by Woodside Energy Limited (WEL), and we thank Mr B. Malseed, Mr M. Varsanyi and Dr L. Smith for their support and access to confidential reports. Three anonymous reviewers provided important direction for revision of the first, draft manuscript.

## References

- Allen G R & Swainston R 1988 The marine fishes of north-western Australia. A field guide for anglers and divers. Western Australian Museum, Perth, Western Australia. 201 pp
- Borcard D, Gillet F & Legendre P 2011 Numerical Ecology with R. Use R! Series. 1st Edition, Springer, pp 154–195.
- Cappo M 2010 Development of a baited video technique and spatial models to explain patterns of fish biodiversity in inter-reef waters. Thesis submitted for the degree of Doctor of Philosophy. School of Marine and Tropical Biology, James Cook University, Townsville. pp 32–54.
- Cappo M, Harvey E H, Malcolm H & Speare P 2003 Potential of video techniques to monitor diversity, abundance and size of fish in studies of Marine Protected Areas. In: "Aquatic Protected Areas – what works best and how do we know?", (Eds Beumer J P, Grant A & Smith D C) World Congress on Aquatic Protected Areas Proceedings, Cairns, Australia, August 2002. Australian Society for Fish Biology, p 455–464.
- Cappo M, Speare P & De'ath G 2004 Comparison of Baited Remote Underwater Video Stations (BRUVS) and prawn (shrimp) trawls for assessments of fish biodiversity in inter-reef areas of the Great Barrier Reef Marine Park. *Journal of Experimental Marine Biology and Ecology* 302(2): 123–152.
- Cappo M, Harvey E & Shortis M 2007a Counting and measuring fish with baited video techniques – An overview. Australian Society for Fish Biology 2006 Workshop Proceedings, p. 101–114.
- Cappo M, De'ath G & Speare P 2007b Inter-reef vertebrate communities of the Great Barrier Reef Marine Park determined by baited remote underwater video stations. *Marine Ecology-Progress Series* 350:209–221.
- Chambers J M, Cleveland W S, Kleiner B & Tukey P A 1983 Graphical Methods for Data Analysis. Wadsworth & Brooks-Cole. p 62.
- De'ath G 2002 Multivariate regression trees: a new technique for modeling species-environment relationships. *Ecology* 83: 1105–1117.
- De'ath G 2007 Boosted trees for ecological modeling and prediction. *Ecology* 88: 243–251.
- Dufrêne M & Legendre P 1997 Species assemblages and indicator species: the need for a flexible asymmetrical approach. *Ecological Monographs* 67: 345–366.
- Elith J, Leathwick J R & Hastie T 2008 A working guide to boosted regression trees. *Journal of Animal Ecology* 77: 802–813.
- Fox N J & Beckley L E 2005 Priority areas for conservation of Western Australian coastal fishes: a comparison of hotspot, biogeographical and complementarity approaches. *Biological Conservation* 125: 399–410.
- Fry G, Heyward A, Wassenberg T, Ellis N, Taranto T, Keesing J, Irvine T, Stieglitz T & Colquhoun J 2008 Benthic habitat surveys of potential LNG hub locations in the Kimberley region. A study commissioned by the Western Australian Marine Science Institution on behalf of the Northern Development Taskforce. Final Report.
- Gomelyuk V E 2009 Fish assemblages composition and structure in three shallow habitats in north Australian tropical bay, Garig Gunak Barlu National Park, Northern Territory, Australia *Journal of the Marine Biological Association of the United Kingdom*. 89(3): 449–460.
- Gotelli N J & Colwell R K 2001 Quantifying biodiversity: procedures and pitfalls in the measurement and comparison of species richness. *Ecology Letters* 4:379–391.
- Harvey E S, Cappo M, Butler J J, Hall N & Kendrick G A 2007 Bait attraction affects the performance of remote underwater video stations in assessment of demersal fish community structure. *Marine Ecology Progress Series* 350: 245–254.
- Hutchins J B 2001 Biodiversity of shallow reef fish assemblages in Western Australia using a rapid censusing technique. *Records of the Western Australian Museum* 20: 247–270.
- Magurran A E & Henderson P A 2003 Explaining the excess of rare species in natural species abundance distributions. *Nature* 422: 714–716.
- Nakamura Y, Horinouchi M, Sano M & Shibuno T 2009 The effects of distance from coral reefs on seagrass nursery use by 5 emperor fishes at the southern Ryukyu Islands, Japan. *Fisheries Science* 75:1401–1408.







- Newman S J, Young G C & Potter I C 2004 Characterisation of the inshore fish assemblages of the Pilbara and Kimberley coasts. FRDC Project No. 2000/132. Final Report. Department of Fisheries, Research Division, Western Australian Marine Research Laboratories. 203 pp
- 'R' Development Core Team 2006 R: A language and environment for statistical computing. Reference Index. R Foundation for Statistical Computing: <http://cran.r-project.org/doc/manuals/refman.pdf>
- Sainsbury K J, Campbell R A, Lindholm R & Whitelaw A W 1997 Experimental management of an Australian multispecies fishery: Examining the possibility of trawl induced habitat modification. In: Pikitch E L, Huppert D D & Sissenwine M P (eds.) Global Trends: Fisheries Management American Fisheries Society Symposium 20, Bethesda, p. 107–112.
- Thompson G G, Withers P C 2003 Effect of species richness and relative abundance on the shape of the species accumulation curve. *Austral Ecology* 28:355–360.
- Travers M J, Newman S J & Potter I C 2006 Influence of latitude, water depth, day *v.* night and wet *v.* dry periods on the species composition of reef fish communities in tropical Western Australia. *Journal of Fish Biology* 69: 987–1017
- Travers M J, Potter I C, Clarke K R, Newman S J & Hutchins J B 2010 The inshore fish faunas over soft substrates and reefs on the tropical west coast of Australia differ and change with latitude and bioregion. *Journal of Biogeography* 37: 148–169.
- Venables W N & Dichmont C M 2004 GLMs, GAMs and GLMMs: an overview of theory for applications in fisheries research. *Fisheries Research* 70:319–337.
- Watson D, Harvey E & Meeuwig J 2008 Pluto LNG project – Baseline fish survey (stereo-BRUVS). Confidential final report. Centre for Marine Futures (CMF) 2008-003. Produced for Sinclair Knight Merz (SKM) 60pp
- Williamson P C, Sumner N R & Malseed B E 2006 A 12-month survey of recreational fishing in the Pilbara region of Western Australia during 1999–2000. Fisheries Research Report No. 153, Department of Fisheries, Western Australia, 61pp
- Wilson G G 1998 A description of the early juvenile colour patterns of 11 *Lethrinus* species (Pisces: Lethrinidae) from the Great Barrier Reef, Australia. *Records of the Australian Museum* 50: 55–83.









## Appendix 1







Summaries of fishes, sharks, rays and sea snakes sighted on BRUVS. The total number recorded (N.fish) is shown as a percentage of the 7108 individuals recorded. The 50th, 75th and 95th percentiles in distribution of the count data are shown for each species. For example, 50% of the BRUVS sites had 2, or less, individuals of the ubiquitous school mackerel *Scomberomorus queenslandicus*, and only 5% of the sites had more than 5 individuals seen in the field of view at one time. The number of BRUVS sites on which the species occurred (N.sites) is also shown as a percentage of the 154 sites sampled in the vicinity of James Price Point. Genera listed as important to fisheries by Newman *et al.* (2004) and Williamson *et al.* (2006) are highlighted in bold.

Order/Family	Scientific Name	Common Name	N.fish	%abun	q50%	q75%	q95%	N.sites	%sites
<i>Carcharhiniformes</i> Hemigaleidae									
	<i>Hemipristis elongata</i>	Fossil shark	2	0	0	0	0	2	1.3
Carcharhinidae									
	<i>Carcharhinus dussumieri</i>	White cheek sharks	8	0.1	0	0	0	7	4.5
	<i>Carcharhinus tilstoni</i>	Australian blacktip shark	35	0.5	0	0	1	32	20.8
	<i>Carcharhinus amblyrhynchos</i>	Grey reef shark	9	0.1	0	0	0	3	1.9
	<i>Carcharhinus melanopterus</i>	Blacktip reef shark	1	0	0	0	0	1	0.6
	<i>Galeocerdo cuvier</i>	Tiger shark	2	0	0	0	0	2	1.3
	<i>Rhizoprionodon taylori</i>	Milk shark	6	0.1	0	0	0	6	3.9
Sphyrmidae	<i>Negaprion acutidens</i>	Lemon shark	2	0	0	0	0	2	1.3
									
	<i>Sphyrna mokarran</i>	Great hammerhead shark	11	0.2	0	0	1	11	7.1
<i>Orectolobiformes</i> Hemiscylliidae									
	<i>Chiloscyllium punctatum</i>	Catshark	4	0.1	0	0	0	4	2.6
Stegostomatidae									
	<i>Stegostoma fasciatum</i>	Leopard shark	6	0.1	0	0	0	6	3.9







Order/Family	Scientific Name	Common Name	N.fish	%abun	q50%	q75%	q95%	N.sites	%sites
Ginglymostomatidae	 <i>Nebrius ferrugineus</i>	Nurse shark	2	0	0	0	0	2	1.3
<b>Rajiformes</b>									
Rhynchobatidae									
	<i>Rhynchobatus djiddensis</i>	White-spotted Shovelnose	14	0.2	0	0	1	14	9.1
Rhinidae									
	<i>Rhina ancylostoma</i>	Shark ray	3	0	0	0	0	3	1.9
<b>Myliobatiformes</b>									
Dasyatidae									
	<i>Himantura uarnak</i>	Stingray	1	0	0	0	0	1	0.6
	<i>Himantura toshi</i>	Whip ray	1	0	0	0	0	1	0.6
	<i>Himantura jenkinsii</i>	Whip ray	6	0.1	0	0	0	5	3.2
	<i>Dasyatis kuhlii</i>	Masked ray	1	0	0	0	0	1	0.6
	<i>Pastinachus sephen</i>	Cowtail Stingray	3	0	0	0	0	3	1.9
<b>Anguilliformes</b>									
Muraenidae									
	<i>Gymnothorax pseudothyrsoides</i>	Moray eel	1	0	0	0	0	1	0.6
	<i>Gymnothorax pale sp</i>	Moray eel	2	0	0	0	0	1	0.6
<b>Elopiiformes</b>									
Elopidae									
	<i>Elops hawaiiensis</i>	Giant herring	10	0.1	0	0	1	9	5.8
<b>Clupeiformes</b>									
Clupeidae									
	<i>Herklotsichthys blackburni</i>	Blackburn's sardine	366	5.1	0	0	5.7	14	9.1
<b>Autlopiiformes</b>									







Order/Family	Scientific Name	Common Name	N.fish	%abun	q50%	q75%	q95%	N.sites	%sites
Synodontidae									
	<i>Saurida sp</i>	Lizardfish	3	0	0	0	0	3	1.9
Siluriformes Ariidae									
	<i>Arius thalassinus</i>	Giant salmon catfish	4	0.1	0	0	0	4	2.6
Scorpaeniformes Scorpaenidae									
	<i>Pterois voltans</i>	Lionfish	2	0	0	0	0	2	1.3
Perciformes Serranidae									
	<i>Epinephelus bilobatus</i>	Frostback cod	41	0.6	0	0	1.3	30	19.5
	<i>Epinephelus coioides</i>	Goldspot cod	4	0.1	0	0	0	4	2.6
	<i>Epinephelus multinotatus</i>	White-blotched cod	3	0	0	0	0	2	1.3
	<i>Epinephelus rivulatus</i>	Chinaman cod	1	0	0	0	0	1	0.6
	<i>Epinephelus quoyanus</i>	Wire-netting cod	1	0	0	0	0	1	0.6
	<i>Epinephelus merra</i>	Wire-netting cod	6	0.1	0	0	0	5	3.2
	<i>Plectropomus maculatus</i>	Bar-checked coral trout	23	0.3	0	0	1	17	11
Sillaginidae									
	<i>Sillago sp</i>	Whiting	55	0.8	0	0	2.3	27	17.5
Echeneidae									
	<i>Echeneis naucrates</i>	Suckerfish	41	0.6	0	0	1.3	31	20.1
Glaucomatidae									
	<i>Glaucomsoma magnificum</i>	Pearl perch	6	0.1	0	0	0	4	2.6









Order/Family	Scientific Name	Common Name	N.fish	%abun	q50%	q75%	q95%	N.sites	%sites
Rachycentridae									
	<i>Rachycentron canadum</i>	Cobia	16	0.2	0	0	1	13	8.4
Carangidae									
	<i>Carangoides malabaricus</i>	Malabar trevally	7	0.1	0	0	0	3	1.9
	<i>Carangoides chrysophrys</i>	Club-nosed trevally	2	0	0	0	0	2	1.3
	<i>Carangoides fulvoguttatus</i>	Gold-spot trevally	59	0.8	0	0	2	35	22.7
	<i>Carangoides hedlandensis</i>	Bump-nosed trevally	95	1.3	0	1	3	53	34.4
	<i>Carangoides talamparoides</i>	White-tongued trevally	2	0	0	0	0	2	1.3
	<i>Carangoides coeruleopinnatus</i>	Onion trevally	1	0	0	0	0	1	0.6
	<i>Carangoides gymnotethus</i>	Bludger trevally	3	0	0	0	0	3	1.9
	<i>Caranx ignobilis</i>	Giant trevally	29	0.4	0	0	1	13	8.4
	<i>Caranx bucculentus</i>	Blue-spotted trevally	5	0.1	0	0	0	2	1.3
	<i>Gnathanodon speciosus</i>	Golden trevally	172	2.4	0	1	6	45	29.2
	<i>Scomberoides commersonianus</i>	Queenfish	31	0.4	0	0	1	29	18.8
	<i>Seriolina nigrofasciata</i>	Black-banded kingfish	8	0.1	0	0	0	7	4.5
	<i>Selar boops</i>	Ox-eye scad	246	3.5	0	0	4.3	14	9.1
	<i>Selaroides leptolepis</i>	Gold-lined trevally	1341	18.9	4	10	35	109	70.8
	<i>Atule mate</i>	Yellow-tail scad	1109	15.6	1	7.8	30	86	55.8
Leiognathidae									
	<i>Leiognathus longispinis</i>	Smithurst's ponyfish	329	4.6	0	1	12.7	40	26
Lutjanidae									
	<i>Lutjanus vitta</i>	Striped seaperch	61	0.9	0	0	0	7	4.5
	<i>Lutjanus sebae</i>	Red Emperor	3	0	0	0	0	2	1.3
	<i>Lutjanus erythropterus</i>	Crimson sea perch	7	0.1	0	0	0	2	1.3
	<i>Lutjanus temminckii</i>	Dark-tailed sea perch	2	0	0	0	0	2	1.3
	<i>Lutjanus carponotatus</i>	Stripey seaperch	95	1.3	0	1	3	40	26
	<i>Lutjanus fulviflamma</i>	Black-spot sea perch	2	0	0	0	0	1	0.6
	<i>Symphorus nematophorus</i>	Chinaman fish	1	0	0	0	0	1	0.6
Haemulidae									









Order/Family	Scientific Name	Common Name	N.fish	%abun	q50%	q75%	q95%	N.sites	%sites
Lethrinidae	<i>Plectorhynchus schotaf</i>	Minstrel Sweetlip	3	0	0	0	0	3	1.9
	<i>Diagramma pictum</i>	Slaty bream/Painted sweetlips	29	0.4	0	0	1	22	14.3
									
Nemipteridae	<i>Lethrinus punctulatus</i>	Blue-spotted emperor	519	7.3	0	2	20.3	51	33.1
	<i>Lethrinus olivaceus</i>	Long-nosed emperor	3	0	0	0	0	3	1.9
	<i>Lethrinus "laticaudis/frenatus"</i>	Blue-lined emperor	3	0	0	0	0	3	1.9
Mullidae									
	<i>Nemipterus peronii</i>	Peron's threadfin bream	5	0.1	0	0	0	4	2.6
	<i>Nemipterus furcosus</i>	Rosy threadfin bream	174	2.4	0	0	7	33	21.4
	<i>Scolopsis monogramma</i>	Monocle bream	29	0.4	0	0	1	22	14.3
	<i>Scolopsis margaritifera</i>	Pearl-streaked monocle bream	1	0	0	0	0	1	0.6
	<i>Pentapodus porosus</i>	False whiptail	1078	15.2	6	12	16.3	119	77.3
	<i>Pentapodus vitta</i>	Western butterflyfish	73	1	0	0	3	28	18.2
Chaetodontidae	<i>Upeneus moluccensis</i>	Gold-band goatfish	1	0	0	0	0	1	0.6
	<i>Upeneus tragula</i>	Bar-tailed goatfish	29	0.4	0	0	1	13	8.4
	<i>Parupeneus indicus</i>	Indian goatfish	3	0	0	0	0	3	1.9
									
Pomacanthidae	<i>Coradion chrysozonus</i>	Orange-banded coralfish	9	0.1	0	0	0.3	8	5.2
	<i>Chelmon marginalis</i>	Margined coralfish	21	0.3	0	0	1	13	8.4
	<i>Chaetodon aureofasciatus</i>	Golden-striped butterflyfish	1	0	0	0	0	1	0.6
Terapontidae	<i>Chaetodontoplus duboulayi</i>	Scribbled angelfish	49	0.7	0	0	2	33	21.4
									
Labridae	<i>Terapon jarbua</i>	Crescent perch	1	0	0	0	0	1	0.6
									
	<i>Anampses lennardi</i>	Blue and yellow wrasse	2	0	0	0	0	1	0.6



Order/Family	Scientific Name	Common Name	N.fish	%abun	q50%	q75%	q95%	N.sites	%sites
	<i>Choerodon cephalotes</i>	Purple tuskfish	46	0.6	0	0	1.3	28	18.2
	<i>Choerodon cauteroma</i>	Blue-spotted tuskfish	37	0.5	0	0	1	27	17.5
	<i>Choerodon vitta</i>	Red-stripe tuskfish	15	0.2	0	0	1	9	5.8
	<i>Choerodon schoenleinii</i>	Black-spot tuskfish	36	0.5	0	0	2	20	13
	<i>Choerodon cyanodus</i>	Blue tuskfish	43	0.6	0	0	2	25	16.2
Scaridae									
	<i>Scarus ghobban</i>	Blue-barred parrotfish	1	0	0	0	0	1	0.6
	<i>Scarus schlegeli</i>	Schlegel's parrotfish	1	0	0	0	0	1	0.6
Pomacentridae									
	<i>Abudefduf septemfasciatus</i>	Banded sergeant	2	0	0	0	0	2	1.3
	<i>Abudefduf sexfasciatus</i>	Scissortail sergeant	3	0	0	0	0	2	1.3
	<i>Pomacentrus wardi</i>	Ward's damselfish	2	0	0	0	0	1	0.6
Pinguipedidae									
	<i>Parapercis multiplicata</i>	Red-banded grubfish	68	1	0	0	2.3	38	24.7
	<i>Parapercis sp</i>	Grubfish	1	0	0	0	0	1	0.6
Ephippidae									
	<i>Platax bataviamus</i>	Hump-headed batfish	2	0	0	0	0	2	1.3
	<i>Platax teira</i>	Round-faced batfish	1	0	0	0	0	1	0.6
	<i>Platax orbicularis</i>	Narrow-banded batfish	1	0	0	0	0	1	0.6
	<i>Zabidius novemaculeatus</i>	Short-finned batfish	1	0	0	0	0	1	0.6
Siganidae									
	<i>Siganus sp</i>	Rabbitfish	1	0	0	0	0	1	0.6
	<i>Siganus argenteus</i>	Spinefoot	20	0.3	0	0	0	5	3.2
Acanthuridae									
	<i>Acanthurus chussumieri</i>	Ornate surgeon-fish	4	0.1	0	0	0	3	1.9
Sphyraenidae									
	<i>Sphyraena jello</i>	Pick-handle barracuda	14	0.2	0	0	1	14	9.1



Order/Family	Scientific Name	Common Name	N.fish	%abun	q50%	q75%	q95%	N.sites	%sites
Scombridae	<i>Sphyraena barracuda</i> 	Great barracuda	6	0.1	0	0	0	6	3.9
	<i>Scomberomorus semifasciatus</i>	Broad-barr mackerel	1	0	0	0	0	1	0.6
	<i>Scomberomorus commerson</i>	Spanish mackerel	6	0.1	0	0	0	6	3.9
	<i>Scomberomorus queenlandicus</i>	School mackerel	327	4.6	2	3	5	138	89.6
	<i>Cybiosarda elegans</i>	Watson's leaping bonito	13	0.2	0	0	1	10	6.5
<b>Tetraodontiformes</b>									
Balistidae									
	<i>Abalistes stellatus</i>	Starry triggerfish	29	0.4	0	0	1.3	20	13
Monacanthidae									
	<i>Monacanthus chinensis</i>	Fan-bellied leatherjacket	10	0.1	0	0	1	10	6.5
Ostraciidae	<i>Paramonacanthus otisensis</i> 	Leatherjacket	36	0.5	0	0	2	20	13
	<i>Cyclichthys orbicularis</i> 	Boxfish	1	0	0	0	0	1	0.6
Tetraodontidae	<i>Torquigener sp</i>	Pufferfish	1	0	0	0	0	1	0.6
	<i>Torquigener pallimaculatus</i>	Orange-spotted toadfish	2	0	0	0	0	2	1.3
	<i>Lagocephalus sceleratus</i>	Silver toadfish/Norwest blowie	2	0	0	0	0	2	1.3
	<i>Feraxodon multistriatus</i> 	Many-striped pufferfish	5	0.1	0	0	0	5	3.2
	<i>Tragulichtys jaculiferus</i>	Globefish	2	0	0	0	0	2	1.3
<b>Reptilia: Squamata</b>									
Hydrophiidae									
	<i>Aipysurus laevis</i>	Olive sea snake	22	0.3	0	0	1	19	12.3
	<i>Hydrophis ornatus</i>	Ornate sea snakes	1	0	0	0	0	1	0.6